

## Semion 3 kV RFEA

RETARDING FIELD ENERGY ANALYSERS FOR ION ENERGY AND FLUX MEASUREMENTS

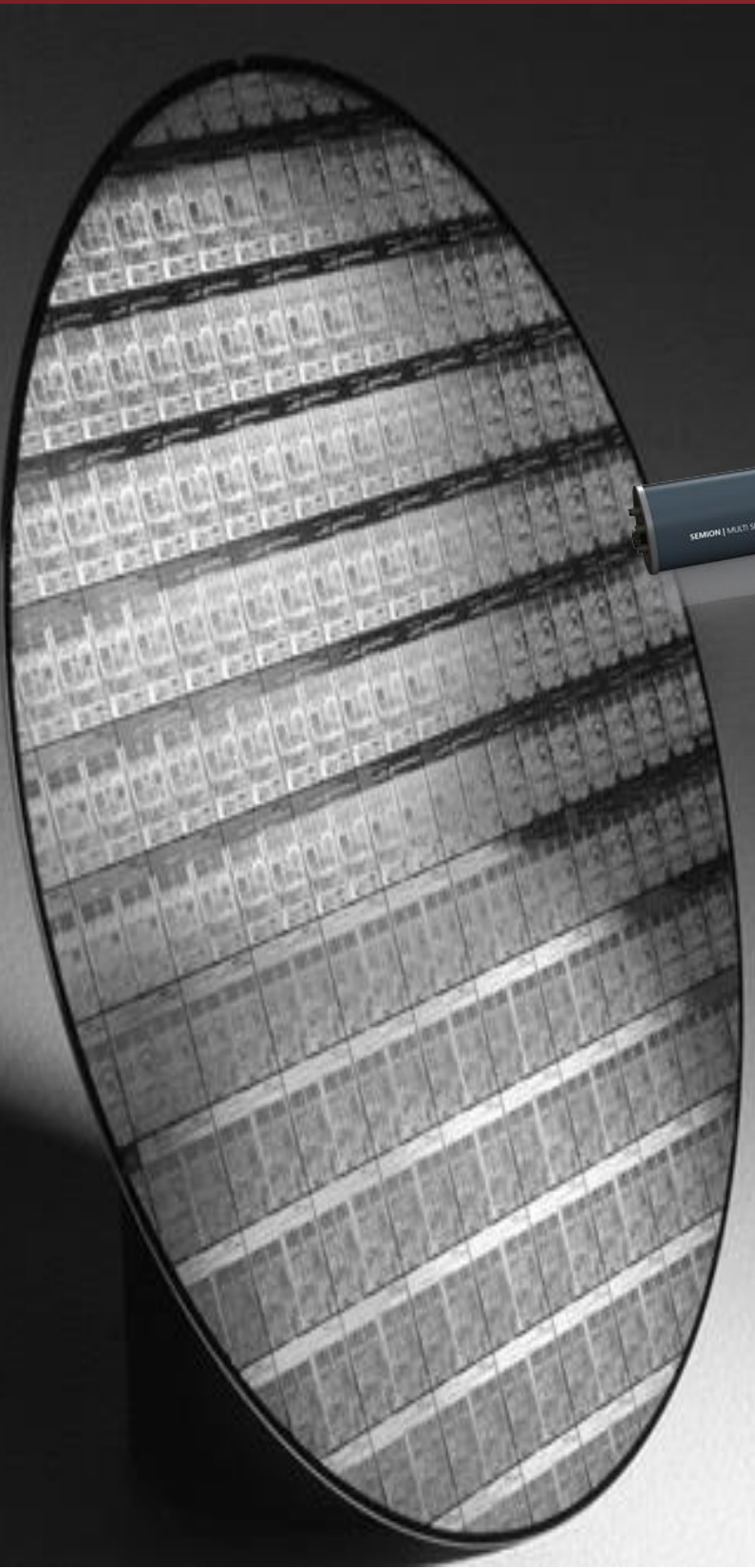

### Semion™ 3 kV RFEA

Retarding Field Energy Analysers

#### Compatible Plasma Types

DC, Pulsed DC, RF, Pulsed RF & Microwave

#### Interchangeable Sensing Elements

Compatible with a wide range of plasma densities and gas pressures.

## Semion RFEA

The Semion 3 kV System is a new Retarding Field Energy Analyser (RFEA) from Impedans Ltd which extends the range of the Semion sensor platform. It can measure the ion flux and ion energy distribution function in real time with up to 3 kV peak-peak RF bias voltage applied, three times what the standard Semion system can achieve. The sensor consists of an anodized aluminium wafer (as standard) with a single sensing element placed where the substrate would normally sit. The sensing element can have various current sensitivities depending on the expected plasma density, covering the full range of plasma applications. The Semion 3 kV System is the ideal sensor for rapid plasma characterisation, based on the industry standard ion energy measurement platform, which has over 100 publications to date.

### Key Features

- Measure the Ion Flux and Ion Energy Distribution with energy range up to 3000 eV (process dependant).
- Suitable for grounded, floating and RF biased conditions.
- Fully automated software analysis including IEDF adjustment for sensor DC bias potential.
- Replaceable sensor elements with different sensitivities ranging from 0.001 Am<sup>-2</sup> to 700 Am<sup>-2</sup>.
- Sensor elements and holder available in anodised aluminium, bare aluminium, or stainless-steel options.

### Key Benefits

- Portable system allowing analysis in multiple chambers using a single system.
- Provides in-situ measurement of Ion Energy Distribution (IED) under plasma processing conditions.
- Provides insight for fundamental research and for plasma model validation.
- Generate process data for customer escalations or product marketing.
- Correlate process performance with the key plasma process drivers (ion energy and ion flux).

### Low Cost of Ownership

The Semion system was designed to have replaceable, low-cost sensing elements, each with a lifetime ranging from 10s to 100s of hours of plasma exposure. The other system components can be used repeatedly without the need for replacement. The sensor holder assembly is easily installed in (and uninstalled from) the processing chamber, making it convenient to move to other plasma tools as required.

### Cost Benefits

Enormous cost benefits can be achieved through the use of the Semion system. Process issues can be identified through direct measurement of the key process drivers in real time. This can be more effective than processing test wafers for offline analysis using costly metrology tools to examine etch or deposition rate uniformity, for example.

### Unparalleled Insight

The key process driver in the majority of plasma processes is the ion energy distribution arriving at the substrate. There are many sensors and instruments on the market to measure the various process inputs such as power, pressure, and gas flow. These measurements provide no insight into what happens at the wafer other than from empirical models. There are also a range of instruments that measure parameters related to the bulk plasma conditions such as plasma density and electron temperature. While these are useful to know, a model of the plasma and sheath adjacent to the wafer is required to predict the ion energy and flux at the wafer. Direct measurement of the ion energy distribution at the wafer position provides the deepest process insight. The Semion system is the only instrument on the market that can provide this type of measurement across a broad range of plasma processing conditions.

### Smart Design for Ease of Use

While the theory of operation and the fine tuning of electrical potentials to be applied to the grid stack (that make up the sensing elements) can be complicated, the user-friendly design of the Semion system makes it easy to use for all levels of expertise. The grid potential configurations are carried out using smart algorithms based on measured DC bias voltage. After minimal configuration, through the intuitive software user interface, an IEDF scan can be performed, and results displayed to the user within seconds.

## Model Options

### Full Systems Options

Table 1: Semion System product family & availability

System Name	Supply Status	Spare Parts Availability			
		Sensor	Holder	Feedthrough	Controller
Semion 500	Obsolete	✗	✗	✗	✗
Semion 800	Obsolete	✓	✓	✓	✗
Semion 2500	Obsolete	✓	✓	✓	✗
Semion Single <sup>1</sup>	Active	✓	✓	✓	✓
Semion Multi <sup>1</sup>	Active	✓	✓	✓	✓
Semion pDC <sup>1</sup>	Active	✓	✓	✓	✓
Semion 3kV	Active	✓	✓	✓	✓

### Control Unit Options

Table 2: Semion System – Controller Options

Part #	Product Name	Max. Scan Voltage Range <sup>2</sup>
02-0550-01	Semion HV   Electronics Unit	± 3000V DC



### Feedthrough Options

Table 3: Semion System – Feedthrough Module Options



Part #	Product Name	Max. DC Withstanding Voltage
02-0548-01	Semion HV   Feedthrough	± 3000V

<sup>1</sup> Has a separate datasheet

<sup>2</sup> Actual scan range is determined by systems components.

### Sensor Holder Options

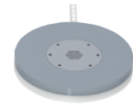
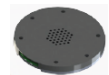

Table 4: Semion HV System – Single Sensor Holder Options<sup>3,4</sup>

Part #	Product Name	Material
02-0387-01	Single Holder   5-pin   Ø50 mm	Anodized Aluminium
02-0388-01	Single Holder   5-pin   Ø50 mm	Aluminium
02-0389-01	Single Holder   5-pin   Ø50 mm	Stainless Steel
02-0396-01	Single Holder   5-pin   Ø70 mm	Anodized Aluminium
02-0397-01	Single Holder   5-pin   Ø70 mm	Aluminium
02-0398-01	Single Holder   5-pin   Ø70 mm	Stainless Steel
02-0405-01	Single Holder   5-pin   Ø100 mm	Anodized Aluminium
02-0406-01	Single Holder   5-pin   Ø100 mm	Aluminium
02-0407-01	Single Holder   5-pin   Ø100 mm	Stainless Steel
02-0417-01	Single Holder   5-pin   Ø150 mm	Anodized Aluminium
02-0418-01	Single Holder   5-pin   Ø150 mm	Aluminium
02-0419-01	Single Holder   5-pin   Ø150 mm	Stainless Steel
02-0429-01	Single Holder   5-pin   Ø200 mm	Anodized Aluminium
02-0430-01	Single Holder   5-pin   Ø200 mm	Aluminium
02-0431-01	Single Holder   5-pin   Ø200 mm	Stainless Steel
02-0441-01	Single Holder   5-pin   Ø300 mm	Anodized Aluminium
02-0442-01	Single Holder   5-pin   Ø300 mm	Aluminium
02-0443-01	Single Holder   5-pin   Ø300 mm	Stainless Steel

### Button Probe™ Sensing Element Options

Table 5: Semion HV – Button Probe Sensing Element Options



Part #	Product Name
02-0366-01	Button Probe   Semion 3kV   Anodized Aluminium   Standard Density   ≤ 300 mTorr
02-0369-01	Button Probe   Semion 3kV   Anodized Aluminium   Low Density   ≤ 300 mTorr
02-0372-01	Button Probe   Semion 3kV   Anodized Aluminium   High Density   ≤ 300 mTorr
02-0367-01	Button Probe   Semion 3kV   Aluminium   Standard Density   ≤ 300 mTorr
02-0370-01	Button Probe   Semion 3kV   Aluminium   Low Density   ≤ 300 mTorr
02-0373-01	Button Probe   Semion 3kV   Aluminium   High Density   ≤ 300 mTorr
02-0368-01	Button Probe   Semion 3kV   Stainless Steel   Standard Density   ≤ 300 mTorr
02-0371-01	Button Probe   Semion 3kV   Stainless Steel   Low Density   ≤ 300 mTorr
02-0374-01	Button Probe   Semion 3kV   Stainless Steel   High Density   ≤ 300 mTorr

<sup>3</sup> The Semion HV single sensor holders have a rated withstanding voltage of 3000V DC.

<sup>4</sup> The Semion HV single sensor holder has a ceramic-bead covered cable terminated with 5-pin plug. Cable length to be specified at time or order.

## Parameters Reported

Table 6: Parameters Reported by Semion Systems.

Parameters measured by the Semion product family	
Parameters Displayed	Description
Semion HV	
IV Curve [Time Averaged   Time Resolved <sup>5</sup> ]	Current v. Voltage Curve
IEDF [Time Averaged   Time Resolved <sup>5</sup> ]	Ion Energy Distribution Function
J <sub>i</sub> [Time Averaged   Time Resolved <sup>5</sup> ]	Ion Flux

## Specifications

### Controller Specifications

Table 74: General Controller Specifications

Controller <sup>6</sup> Environmental Specifications	
Mains voltage	100 – 240 V AC
Mains Current	1.6 A AC
Mains frequency	47 – 63 Hz
Installation category	II
Pollution degree	1
Max. relative humidity	95%, non-condensing
Max. operating temperature	55°C
Max. altitude	3000 meters
Protection rating	IP20 (IEC 60529)

<sup>5</sup> Semion HV require a time resolved feedthrough and sensor must be mounted on a grounded surface.

<sup>6</sup> All Semion controller models.

**Table 8: Semion HV Controller Specifications**

Controller Operating Specifications	
# Voltage Channels	4 (G1/G2/G3/C)
Voltage Scan Range	-3000 V to +3000 V per channel
Max. Current	±1 mA per channel
Connectivity	USB 2.0
PC Operating System	Windows 7 / 8 / 10
Sampling Rate	1 MS/s
Data Acquisition Resolution	16 bit
Time Resolved Step Resolution	1 μs
External Sync (for time resolved mode)	TTL
Synchronization frequency range	4 Hz to 100 kHz
Electrical Connections	4x HV BNC connectors

### Feedthrough Module Specifications

**Table 9: Semion HV Feedthrough Module Specifications**

Feedthrough Module Specifications	
# Voltage I/O Channels (Airside)	4 inputs (G1/G2/G3/C), 1 output (G0)
DC Withstanding Voltage	3000 V for each channel
Max. Current <sup>27</sup>	±60 μA per channel
Electrical Connections (Airside)	4x HV BNC connectors
Connectivity	HV cables to controller, Ethernet cables to controller
Sensor DC Voltage Measurement	Requires voltmeter connected to G0 port
Vacuum Flange Options	KF40, CF40
Vacuum Side Interface	Ceramic tube (Ø25 mm) with a 5-pin socket
With RF Filter Module	
Frequency Range	400 kHz – 60 MHz
Max. RF Bias Voltage (Applied to Sensor)	3000 V peak-to-peak (@ 13.56MHz)
With Time Resolved Module	
Time Resolution	5 μs
Sensor Bias Conditions	Grounded only

## Sensor Holder Specifications

Table 10: Semion HV – Single Sensor Holder Specifications

Single Sensor Holder Specifications	
Holder Diameter	100/150/200/300 mm
Holder Thickness	5 mm
Holder Material	Aluminium/Anodized Aluminium/Stainless Steel
Protective Cable Shielding	Ceramic fish-spine beading
Cable OD	13 mm
Cable Length	650 mm standard, customizable to several meters
Cable Bend Radius	50 mm
Cable Plug	Proprietary 5 pin plug
Button Probe Receiver Pocket OD	33 mm
Button Probe Fixings	2x M2x5 mm countersunk screws
Max. operating temperature	150° C

## Button Probe – Sensing Element Specifications

Table 5: Semion HV – Button Probe Specifications

Sensing Element Specifications	
Button Probe Diameter	35 mm
Button Probes Thickness	3.2 mm
Button Probe Material	Aluminium/Anodized Aluminium/Stainless Steel
# Sensing Apertures	1/7/37 [low/high/standard density respectively]
Aperture Diameter	10/0.5/0.8 mm [low/high/standard density respectively]
# Grids	4 (G0/G1/G2/G3) & 1 Collector
Grid Hole Size	25 x 25 microns (square holes)
Grid Transparency	54% (High/Standard density), 70% (Low density)
Pressure Range Options	≤ 100 mTorr (≤ 3000 eV) & ≤ 1.5 Torr (≤ 150 eV)
Ion Flux Conversion Factors	5.30e4/8.56e6/6.32e5 [low/high/standard density respectively]
Button Probe Fixings	2x M2 threaded screw holes
Max. operating temperature	150° C
DC Withstanding Voltage	3000 V (≤ 300 mTorr)



## Dimensional Drawings

### *Semion Controller*

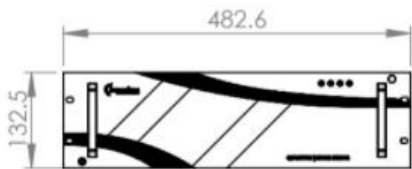

Front View

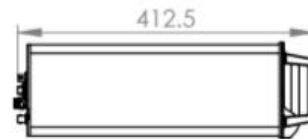

Side View

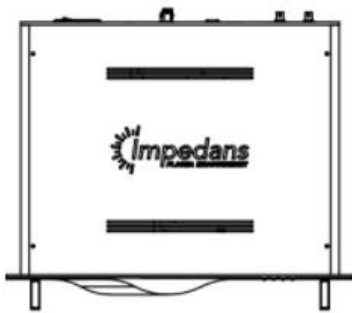

Plan View



Isometric View

*Figure 1: Dimensional drawings of the Semion controller. All dimensions are in mm. Form factor and outer dimensions are the same for all Semion controller models.*

**Semion Feedthrough | 17 Pin Models**

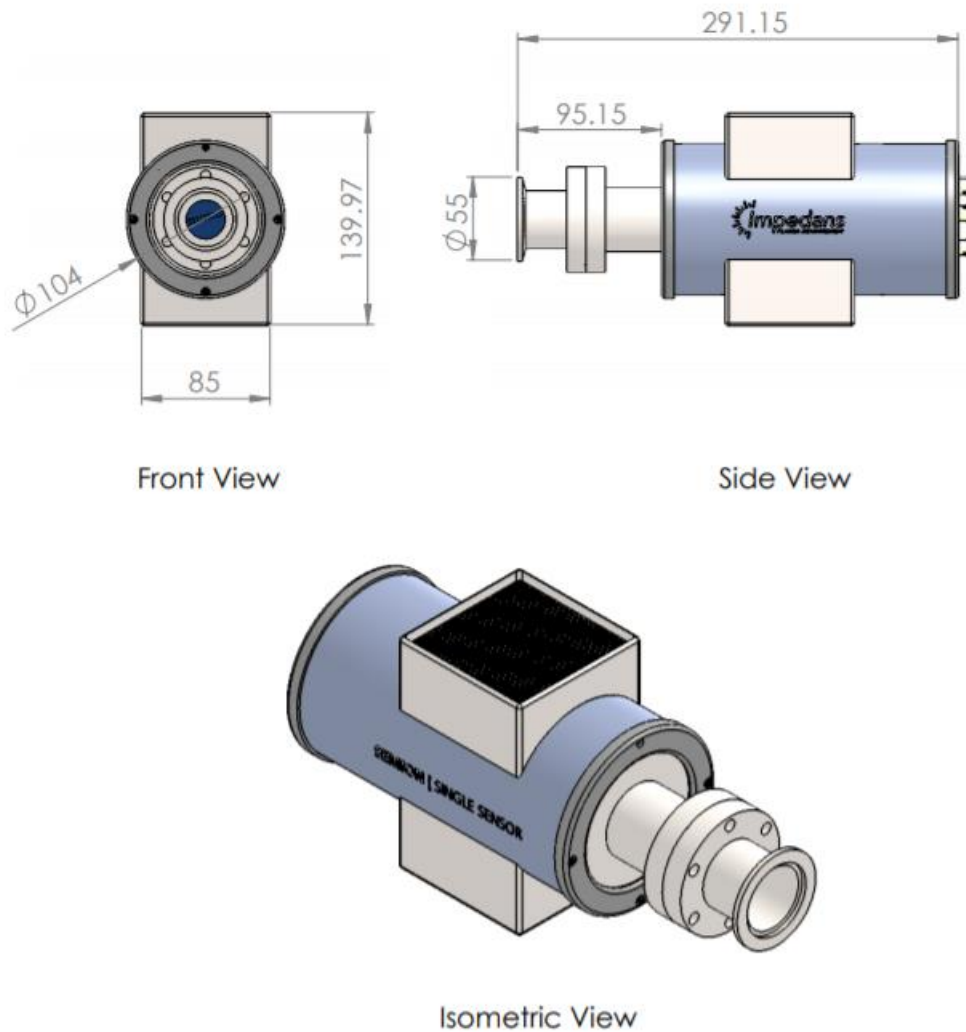

Figure 2: Dimensional drawings of the Semion feedthrough, 17 pin model. It shows an optional CF-to-KF adapter. All dimensions are in mm. Form factor and outer dimensions are the same for all Semion feedthrough models, except the 4 & 5 pin versions.

**Semion Single Sensor Holders | 17 Pin Models**

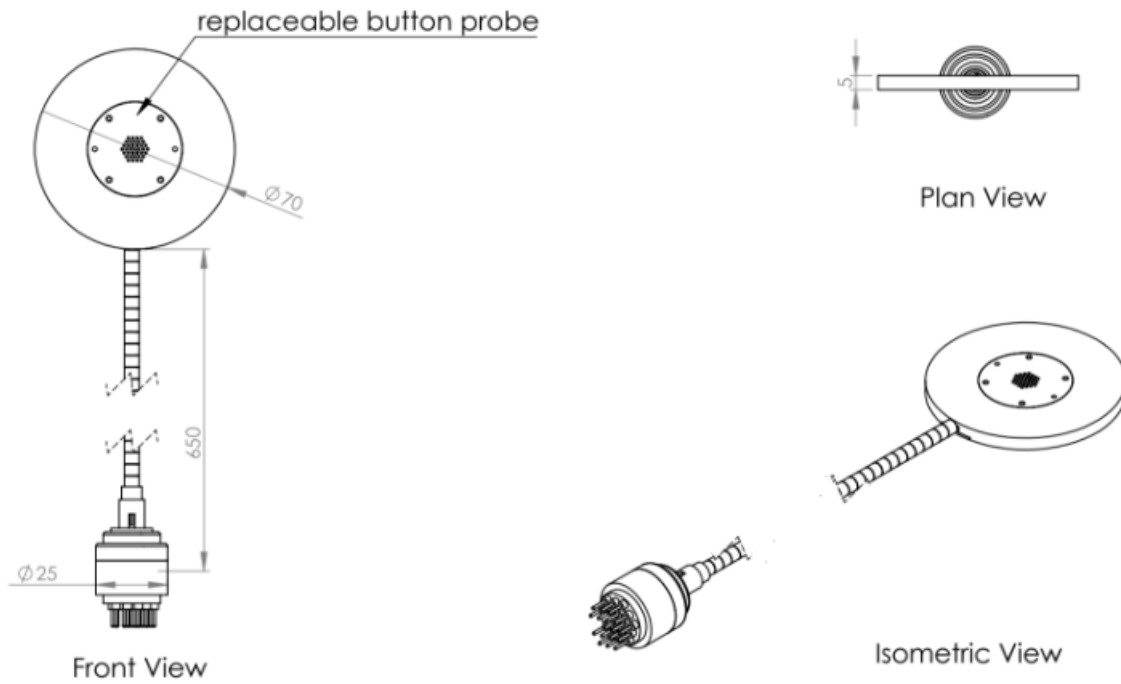

Figure 3: Dimensional drawings of a 70 mm diameter Semion Single sensor holder with 17 pin plug. All dimensions are in mm. The cable length can be specified at the time of order. Drawing for other models available on request.

**Semion Multi Sensor Holders**

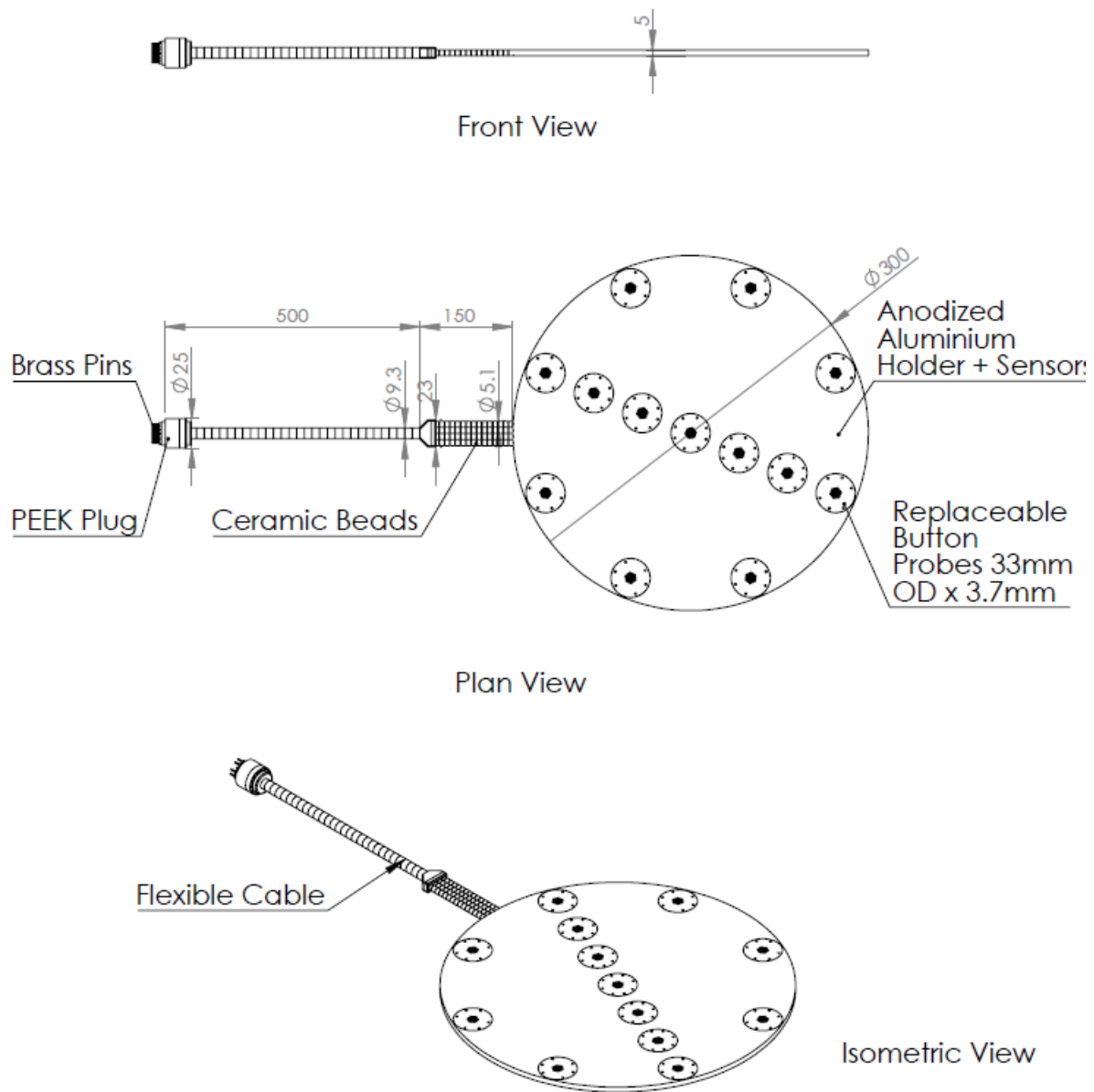
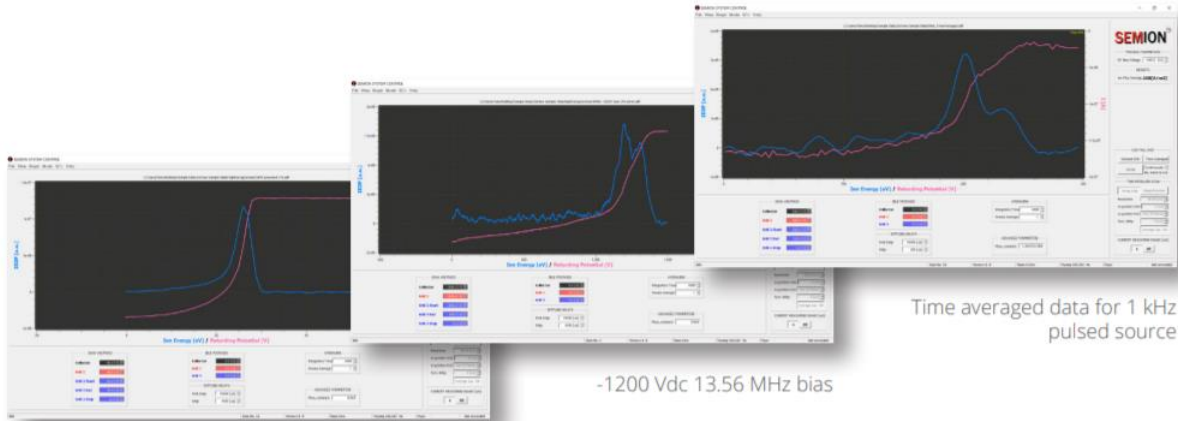

Figure 4: Dimensional drawings of a 300 mm diameter, 13 sensor, Semion Multi holder with 17 pin plug. All dimensions are in mm. The cable length can be specified at the time of order. Drawing for other models available on request.

## Software Screenshots



Grounded scan in Argon

